

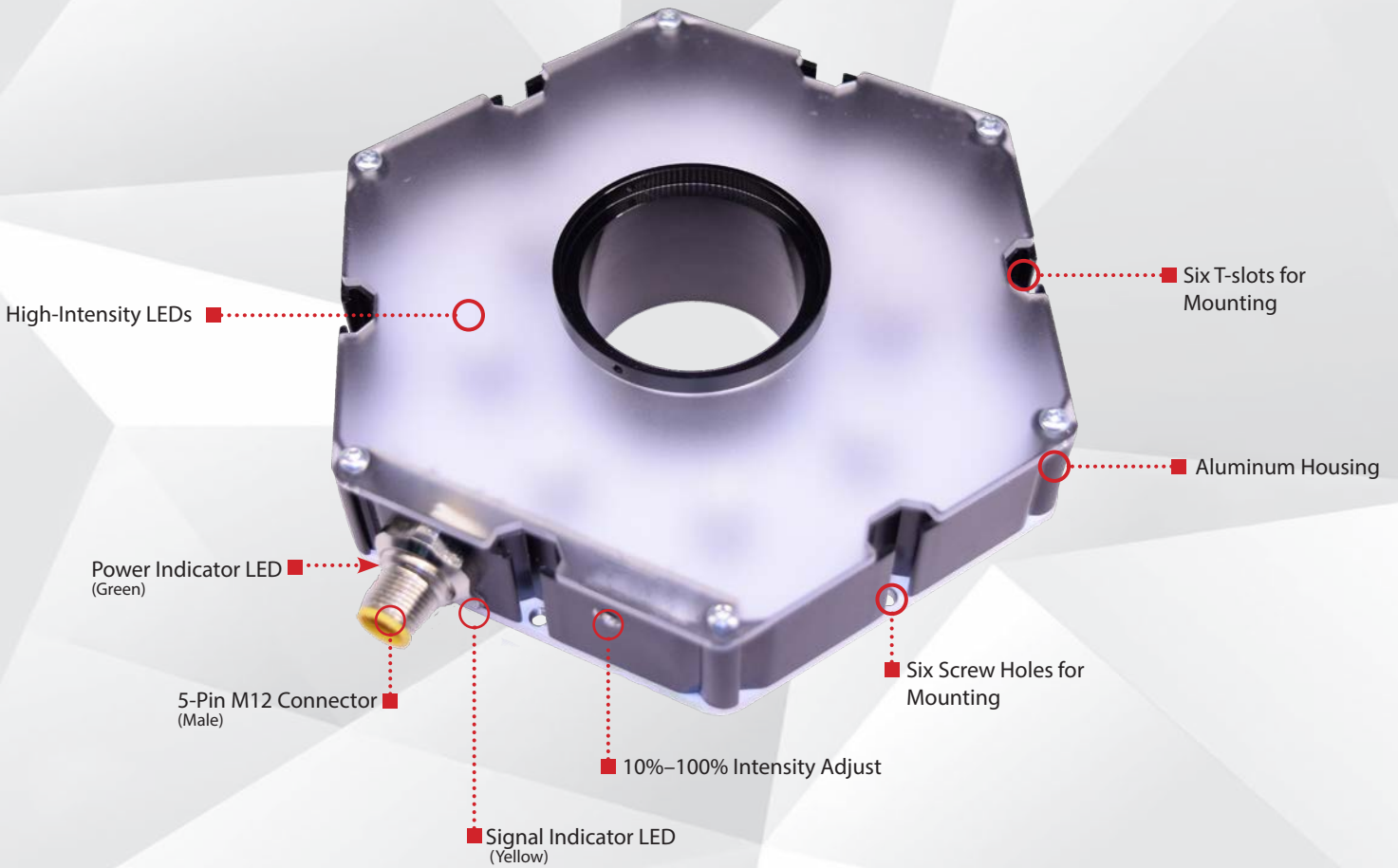

smart
vision lights

R130 *EZ Mount* RING LIGHT

P R O D U C T D A T A S H E E T



Warranty

10
YEAR

Compliant

IEC
62471

Compliant

CE
RoHS

Rated

IP
50

Connector

5-PIN
M12

PRODUCT HIGHLIGHTS

- ✓ 5-pin M12 quick connect
- ✓ Built-in smart driver
- ✓ PNP and NPN trigger input signal
- ✓ Conversion adapters for different cameras available
- ✓ Intensity adjustable from 10%–100% using built-in potentiometer





PRODUCT INFORMATION

Heat is dissipated through the aluminum housing, allowing the R130 to be run at a higher current and a greater intensity. Its simple plug-and-play 5-pin M12 connector is easy to use. The 10%-100% intensity control gives users full control over light output. A standard 42 mm inner hole diameter allows for use with nearly all camera systems with available step-up and step-down conversion kit adapters.



PRODUCT SPECIFICATIONS

Electrical Input	24VDC +/-5%
Input Current	Max. 460 mA
Wattage	Max. 11.1 W
Strobe Input	PNP > +4VDC or greater to activate NPN > GND (<1VDC) to activate
PNP Line	4 mA @ 4VDC 10 mA @ 12VDC 20 mA @ 24VDC
NPN Line	15 mA @ ground (0VDC)
Yellow Indicator LED	LED Strobe Indicator ON = Light Active
Green Indicator LED	ON = Power
Continuous Mode	NPN can be tied to ground OR PNP can be tied to 24VDC (not both)
Potentiometer	270° turn pot — intensity control of 10%–100%. Turn clockwise to increases intensity.
Analog Intensity	The output is adjustable from 10%–100% of brightness by a 1–10VDC signal. (Jumpering pin 5 to pin 1 will provide maximum intensity.)
Connection	5-pin M12 connector
Ambient Temperature	-18°–40°C (0°–104°F)
IP Rating	IP50
Weight	~325 g
Compliances	CE, RoHS, IEC 62471
Warranty	UV LEDs have a 2 year warranty, all other LEDs have a 10 year warranty. For complete warranty information, visit smartvisionlights.com/warranty .



WIRING CONFIGURATION

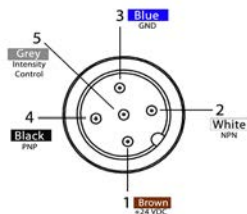

Pin layout for light (Male Connector)

Pin	Function	Signal	Wire Color
1	Power In	+24VDC	BROWN
2	NPN	Sinking Signal	WHITE
3	GND	Ground	BLUE
4	PNP	Sourcing Signal	BLACK
5	Intensity Control	1–10VDC	GREY*

* Some cables use green/yellow for pin 5

For maximum intensity, tie pin 5 to pin 1 at +24VDC.

For continuous mode: Tie PNP (pin 4) can be tied to +24VDC (pin 1) **or** tie NPN (pin 2) can be tied to Ground (pin 3).

NOTICE

If Analog 1–10VDC is not used to control light intensity, analog input must be connected to +VDC (24VDC) — jumper pin 5 to pin 1.



RESOURCE CORNER

Additional resources, including CAD files, videos, and application examples, are available on our website.



LIGHT PATTERNS

Smart Vision Lights recommends the R130 be used at a working distance between 300 mm and 4000 mm.

Beam Diameter (White Light)—5700K

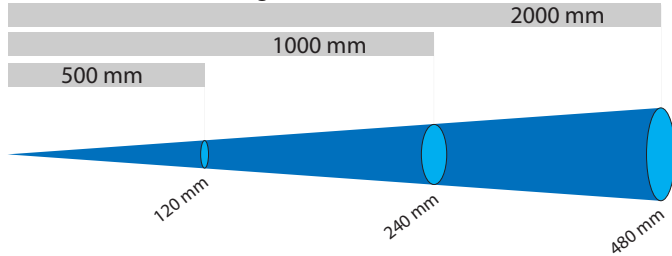

Beam Diameter (White Light)—5700K

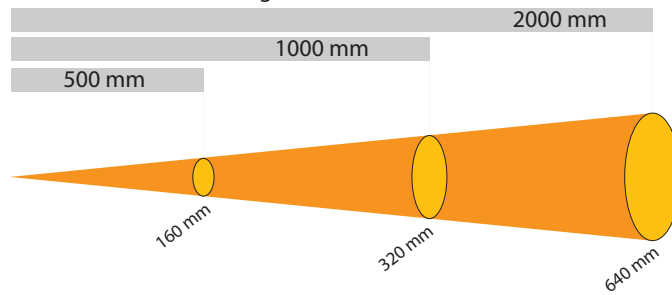

LIGHTING PATTERN FOR THE R130-XXX-N

Working Distance mm (inches)	Pattern (80%–100% measured intensity) mm (inches)
500 mm (19.7")	120 mm (~5.9")
1000 mm (39.4")	240 mm (~11.8")
2000 mm (78.8")	480 mm (~23.6")

Typical Output Performance	Illuminance (Lux)
Distance = 500 mm	11,600
<i>Illuminance measurement taken on White Lights—5700K</i>	

LIGHTING PATTERN FOR THE R130-XXX

Working Distance mm (inches)	Pattern (80%–100% measured intensity) mm (inches)
500 mm (19.7")	160 mm (~3.5")
1000 mm (39.4")	320 mm (~4.7")
2000 mm (78.8")	640 mm (~6.3")

Typical Output Performance	Illuminance (Lux)
Distance = 500 mm	8,000
<i>Illuminance measurement taken on White Lights—5700K</i>	

The R130 Ring Light produces a uniform light pattern.

Working Distance = 500 mm Grid set to 25 mm x 25 mm

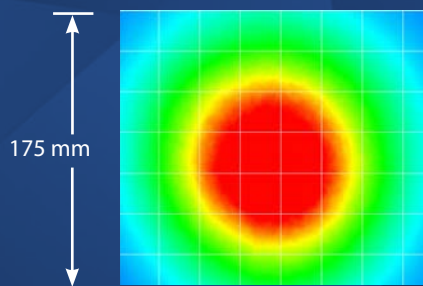

Narrow

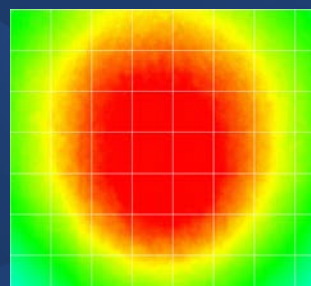

Wide



PRODUCT DRAWING

CAD files available on our website.
Dimensions are in mm.

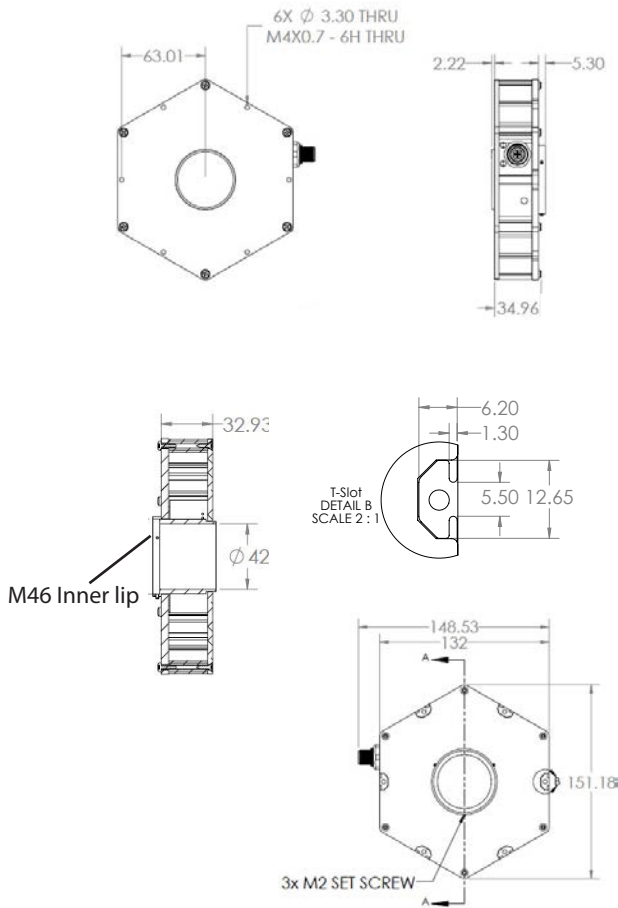

ILLUMINATION

R130 Series of Ring Lights works best for:

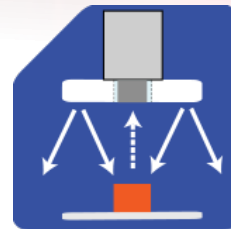

Radial



EYE SAFETY



According to IEC 62471: 2006. Full documentation available upon request.

Notice

Exempt Group: No photobiological hazard to eyes or skin even for continuous, unrestricted use. Applicable for wavelengths 625, 850, and 940.

Caution

Risk Group 1: Possibly hazardous optical radiation emitted from this product. Do not stare at operating lamp. May be harmful to eyes. Safe for most applications except prolonged exposure. Applicable for wavelengths 470, 505, 530, and WHI.

Notice

Risk Group 1: UV emitted from this product. Minimize exposure to eyes and skin. Use appropriate shielding. Safe for most applications except prolonged exposures. Applicable for wavelengths 395.

Caution

Risk Group 2: UV emitted from this product. Eye or skin irritation may result from exposure. Use appropriate shielding. Does not pose optical hazard if aversion responses limit exposure. Applicable for wavelengths 365.



PART NUMBER

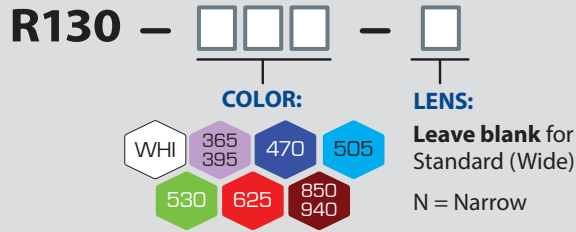

Part Number Examples:

- R130-625** R130, 625 Red Wavelength, Standard (Wide) Lens
- R130-WHI-N** R130, White, N (Narrow) Lens

Additional wavelengths and lens options available upon request.



LENS OPTICS

WIDE (STANDARD)

Wide, 30° angle-cone lenses project a large area of illumination. They create a floodlight effect, can be used for short working distances.

NARROW

Narrow, 14° angle-cone lenses project a narrow beam of illumination and are used for long working distances.

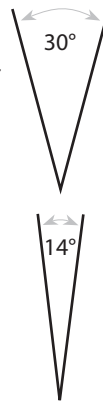

When to Use a Linear Polarizer?

Polarizing filters can reduce reflections on specular (Dielectric or nonmetal) surfaces.

A Linear Polarizer has a typical transmission of 38 percent while blocking 62 percent of the light not in the polarization plane.

WARNING: Running a light in continuous operation while using a standard polarizer with certain wavelengths (e.g. white, blue) may burn of the polarizer.

* Additional lens options available upon request.



STEP-UP/STEP-DOWN ADAPTER KITS

Step-Up/Step-Down Adapter Kits allow the M46 thread on ring lights to be mounted directly to the threads found on the front-end of most popular lenses.

Step-Up Adapters allow for mounting a lens that is smaller in diameter to an EZ Mount Ring Light, while Step-Down Adapters allow for mounting a larger lens to an EZ Mount Ring Light.

These kits include: a set of screws and a hex wrench.

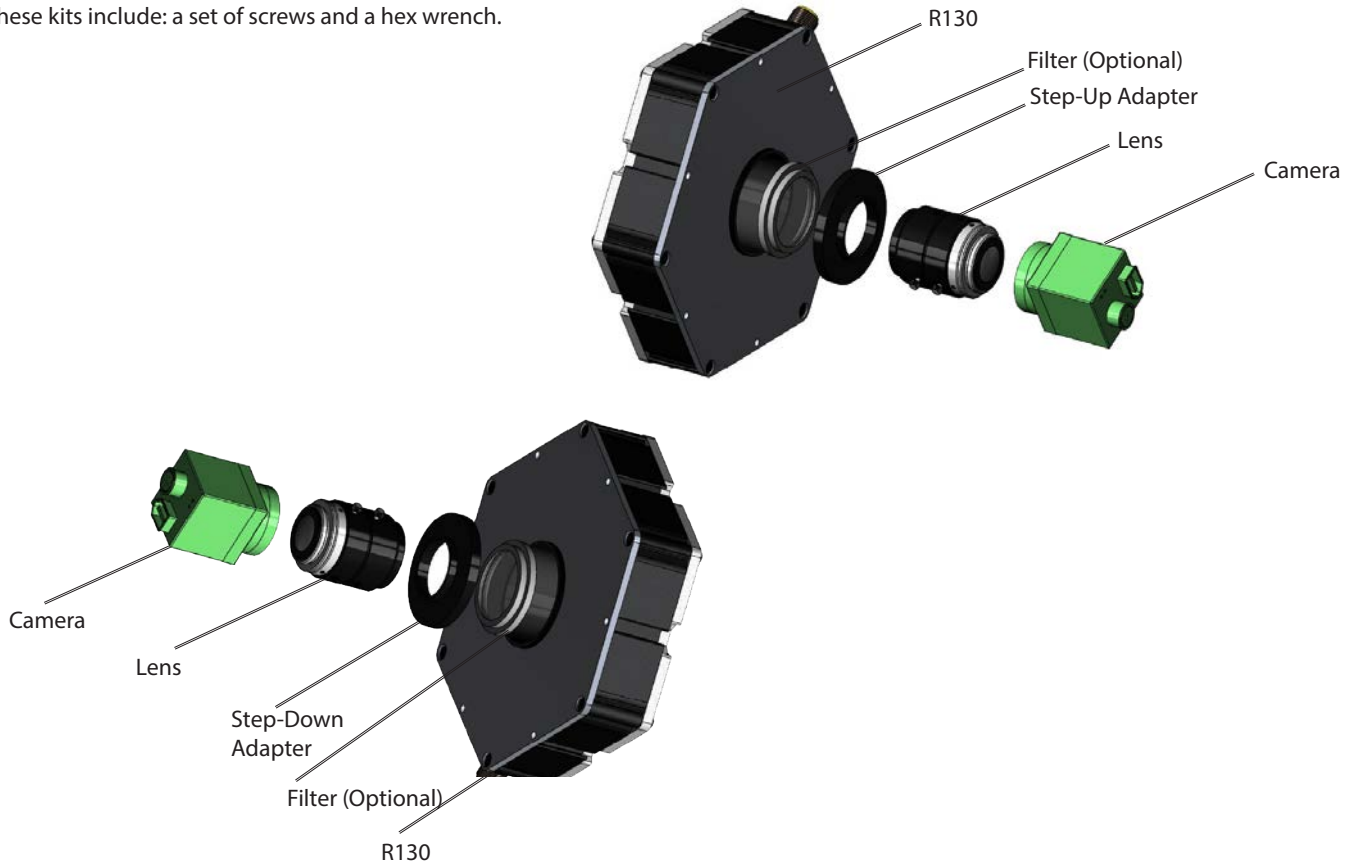

STEP-UP/STEP-DOWN ADAPTER KITS PART NUMBERS

STEP-DOWN ADAPTER

SD- **- 46**

LENS THREAD SIZE RING LIGHT THREAD SIZE

49
52
55
58
62
67
72

STEP-UP ADAPTER

SU- **- 46**

LENS THREAD SIZE RING LIGHT THREAD SIZE

25.5
27
30.5
34
35.5
37
39
40.5
43

CAMERA MOUNTING ADAPTERS

When mounting a camera directly on to an EZ Mount Ring Light, a Double-Female (DF) threaded camera adapter is used.

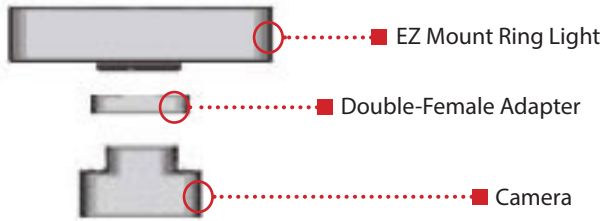

DOUBLE-FEMALE ADAPTER

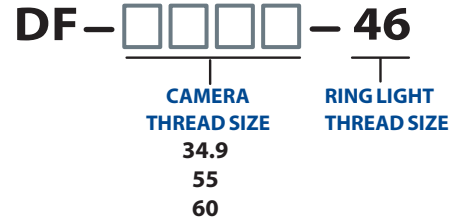

*When mounting an EZ Mount Ring Light, a double-female adapter is used.

MOUNTING

Mounting options on the R130 EZ Mount Ring Light include six T-slots and six M4 threaded holes.

Optional Mounting Hardware:

T-slots = M5 x 0.8 mm T-nut

Threaded screw holes = M4 screws

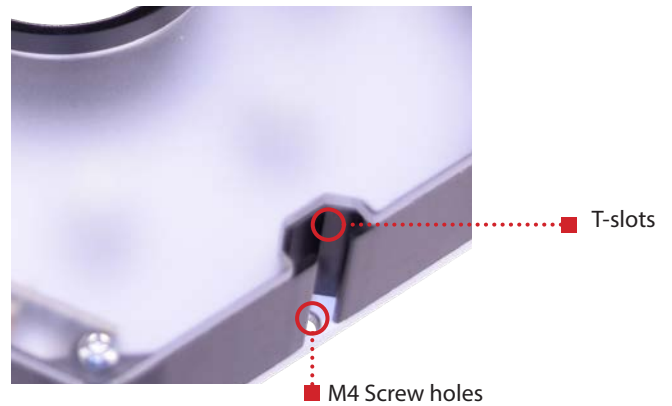

CAMERA MOUNTING EXAMPLES

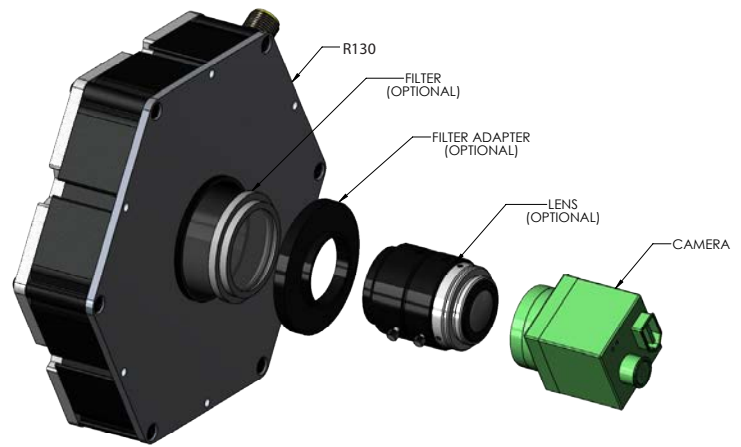
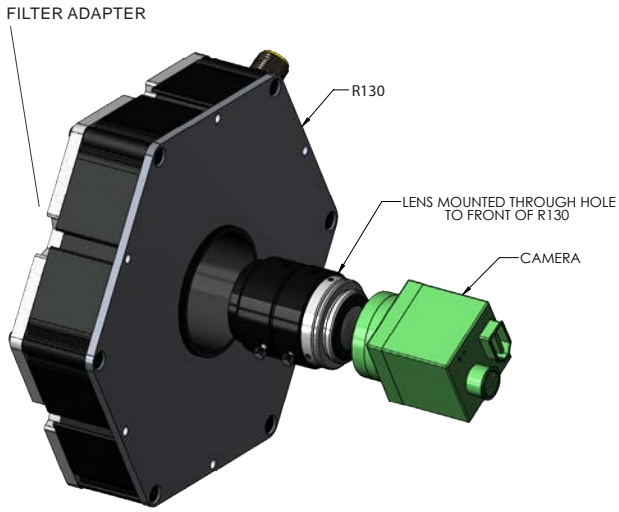



ACCESSORIES

Step-Up Kits



Lens Thread Size	Part Number
25.5 mm	SU25.5-46
27 mm	SU27-46
30.5 mm	SU30.5-46
34 mm	SU34-46
35.5 mm	SU35.5-46
37 mm	SU37-46
39 mm	SU39-46
40.55 mm	SU40.5-46
43 mm	SU46-46

Camera Adapters



Camera Thread Size	Part Number
55 mm	DF55-46
60 mm	DF60-46
34.5 mm	DF34.5-46

Step-Down Kits



Lens Thread Size	Part Number
49 mm	SD49-46
52 mm	SD52-46
55 mm	SD55-46
58 mm	SD58-46
62 mm	SD62-46
67 mm	SD67-46
72 mm	SD72-46

Camera Mounting Adapter



Description	Part Number
Adapter	BKT0030-KIT

Power Cables



Length	Part Number
5 m	5PM12-5
10 m	5PM12-10
15 m	5PM12-15

Power Adapters*



Description	Part Number
AC, 24 Volt, 1.7 Amp	T1 Power Supply

*European Versions Available (Add -EURO to end of T1. Example T1-EURO Power Supply)

Variable Control Pot



Description	Part Number
Controls the intensity of the light	IVP-C1

Diffuser



Description	Part Number
Diffuser Kit	R130-DKIT

Linear Polarizer

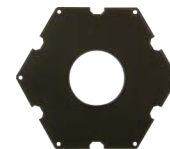

Description	Part Number
Linear Polarizer Kit	R130-LP



GLOSSARY

This glossary covers all Smart Vision Lights product families; some content in this section may not apply to this specific light.

TERMINOLOGY

OverDrive™ Lights include an integrated high-pulse driver for complete LED light control.

Continuous Operation Light stays on continuously.

Multi-Drive™ Combines continuous operation and OverDrive™ strobe (high-pulse operation) mode into one easy-to-use light.

Built-In Driver The built-in driver allows full function without the need for an external controller.

Camera to Light Connect the light directly to the camera, without the need for additional controllers or equipment.

Polarizers Filters that reduce reflections on specular surfaces.

Diffuser Used to widen the angle of light emission, reduce reflections, and increase uniformity.

TYPES OF ILLUMINATION

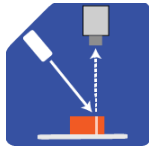

Projector

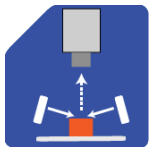

Dark Field

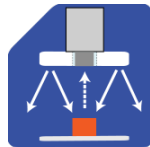

Radial

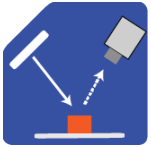

Bright Field

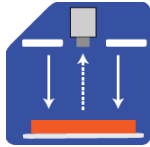

Direct

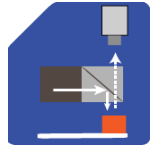

Axial

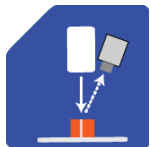

Line

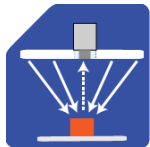

Diffuse Panel

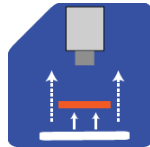

Backlight

COMMON COLOR/WAVELENGTHS LEGEND

Wavelength options range from 365 nm to 1550 nm.*
Additional wavelengths available for many light families.

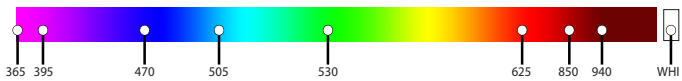

*See Part Number section for **this light** available standard wavelengths.



Shortwave infrared LEDs are available in 1050 nm, 1200 nm, 1300 nm, 1450 nm, and 1550 nm.*

*Check Part Number section to see if **this light** is available in SWIR wavelengths.