



- Power over Ethernet
- IEEE 1588 PTP
- Trigger over Ethernet
- Ultra-compact design

Small and powerful

Ultra-compact GigE Vision cameras

Mako G-811 with Sony IMX546 runs 14.7 frames per second at 8.1 MP resolution.

Mako is an attractively priced GigE Vision-compliant camera in a compact rugged industrial housing. Many models include advanced functionalities such as Precision Time Protocol (PTP), Trigger over Ethernet (ToE) Action Commands, and Power over Ethernet (PoE). Screw mount RJ45 connector and multiple I/Os facilitate your straightforward system integration. Mako cameras are also available as Near Infrared (NIR) and polarizer variants.

Easy software integration with Allied Vision's [Vimba Suite](#) and compatibility to the most popular [third party image-processing libraries](#).

See the [Modular Concept](#) for lens mount, housing variants, optical filters, case design, and other modular options. See the [Customization and OEM Solutions](#) webpage for additional options.

Specifications

Mako G-811	
Interface	IEEE 802.3 1000BASE-T, IEEE 802.3af (PoE)
Resolution	2856 (H) × 2848 (V)
Sensor	Sony IMX546
Sensor type	CMOS
Shutter mode	Global shutter
Sensor size	Type 2/3
Pixel size	2.74 μm × 2.74 μm

Mako G-811	
Lens mounts (available)	C-Mount, CS-Mount
Max. frame rate at full resolution	14.7 fps
ADC	12 Bit
Image buffer (RAM)	64 MByte
Imaging performance	
Imaging performance data is based on the evaluation methods in the EMVA 1288 Release 3.1 standard for characterization of image sensors and cameras. Measurements are typical values for monochrome models measured at full resolution without optical filter. Contact Sales or AE for more information.	
Quantum efficiency at 529 nm	70 %
Temporal dark noise	2.4 e ⁻
Saturation capacity	9275 e ⁻
Dynamic range	69.9 dB
Absolute sensitivity threshold	3.0 e ⁻
Output	
Bit depth	12 Bit
Monochrome pixel formats	Mono8, Mono12, Mono12Packed
YUV color pixel formats	YUV411Packed, YUV422Packed, YUV444Packed
RGB color pixel formats	RGB8Packed, BGR8Packed
Raw pixel formats	BayerRG8, BayerRG12, BayerRG12Packed
General purpose inputs/outputs (GPIOs)	
Opto-isolated I/Os	1 input, 3 outputs
Operating conditions/dimensions	
Operating temperature	+5 °C to +45 °C housing temperature
Power requirements (DC)	10.8 to 26.4 VDC AUX or 802.3at Type 1 PoE
Power consumption	3.3 W at 12 VDC; 2.8 W PoE
Mass	80 g (with C-Mount)
Body dimensions (L × W × H in mm)	60.5 × 29.2 × 29.2 (including connectors)
Regulations	CE: 2014/30/EU (EMC), 2011/65/EU, including amendment 2015/863/EU (RoHS); FCC Class B; CAN ICES-003

Quantum efficiency

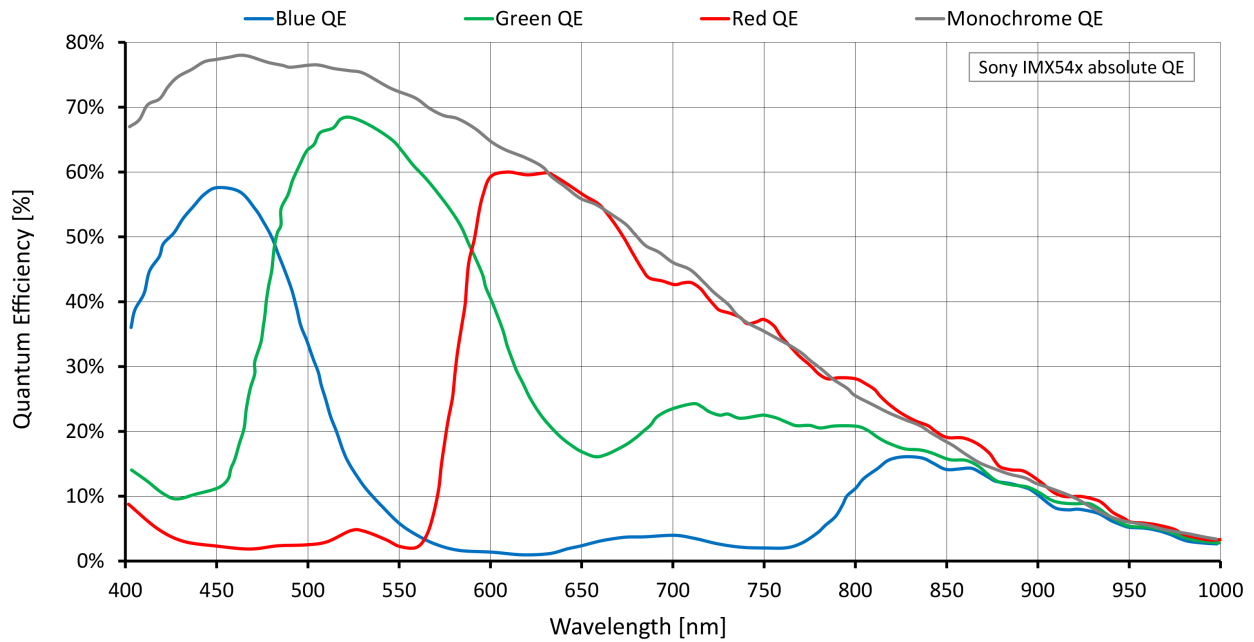

Features

Image optimization features:

- Auto gain (manual gain control: 0 to 40 dB; 0.1 dB increments)
- Auto exposure (exposure time control varies by pixel format)
- Auto white balance (color models)
- Binning (vertical binning is not supported by color models)
- Color transformation, hue, saturation (color models)
- Decimation
- Gamma correction
- One look-up table
- Region of interest, separate region for auto features

Camera control features:

- Event channel

- Image chunk data
- IEEE 1588 Precision Time Protocol
- Storable user sets
- StreamBytesPerSecond (bandwidth control)
- Stream hold
- Sync out modes: Trigger ready, input, exposing, readout, imaging, strobe, GPO
- Temperature monitoring (main board)
- Trigger over Ethernet Action Commands

Technical drawing

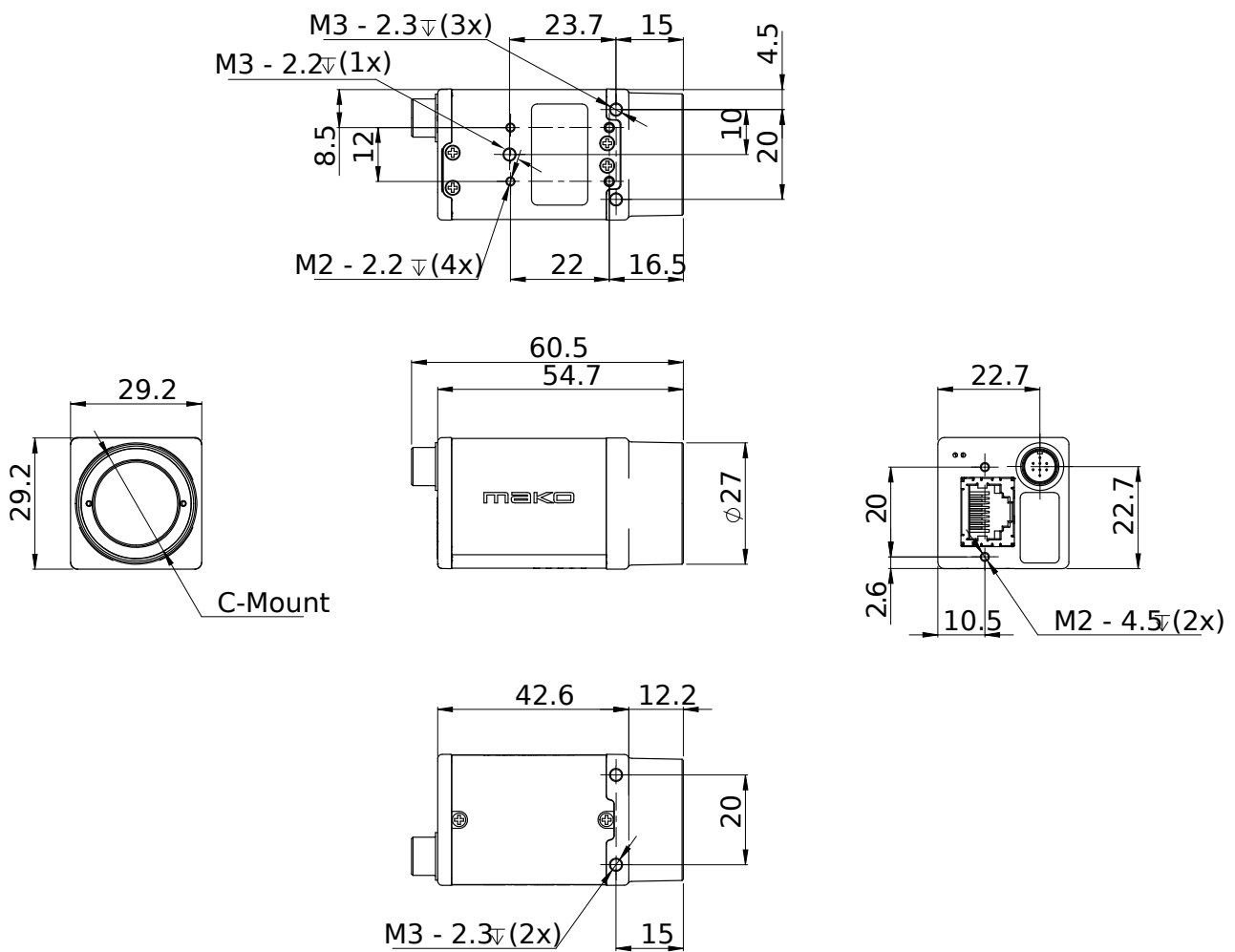

Applications

Mako G is suitable for all typical applications in machine vision:

- Robotics
- Quality control
- Inspection, surveillance
- Industrial imaging
- Machine vision
- Logistics